



The average annual per capita paper use in the USA in 2001 was 700 pounds. The average annual per capita paper use in the rest of the world was 110 pounds. This is equal to approximately 28 print outs per day every day. Excessive use of paper wastes landfill space, water, chemicals and the energy resources required to recycle the paper. Join TiLite in its efforts to reduce paper use by filling out this order form online and sending it via email. To learn more [click here](#) or visit: [tilite.com/thinkgreen.php](http://tilite.com/thinkgreen.php).

The TiLite® TX Order Form is a digital order form and may be filled out on your computer using Adobe® Acrobat® or Adobe® Reader®. For your convenience the order form may then be saved and emailed directly to TiLite's Customer Service Team. Adobe® Acrobat® is recommended in order to take full advantage of the functions on this order form.

To save the completed Order Form to your desktop using Adobe® Reader®: (1) Fill out the order form completely (you will not be able to make changes once the order form is saved using this program). (2) Go to File and select Print; (3) Select Adobe PDF from your list of printers; (4) Select Print again; (5) Select the destination where you would like the file saved; and (6) Select Save. The "Quote This Chair" or "Order This Chair" function on page 7 will not work with Adobe® Reader®.

[Click here](#) to download for free Adobe® Reader® or to purchase Adobe® Acrobat®.

DEALER INFORMATION			RTS INFORMATION		
Dealer:			RTS:		Phone:
Account:	PO:		Email:		
Ordered By:			SHIP TO INFORMATION		
Address:			Name:		Ship Via:
City:	State:	Zip:	Address:		
Phone:	Fax:		City:	State:	Zip:
Email:			Phone:		Fax:
Mark For:			TiLite Information		
			Ship Date:		Order #:

**Please Fax to the TiLite Customer Service Team at 866.586.2413 or 509.586.2413**



TiLite TX shown with Rigid Folding Mechanism "RFM" and other available options.

### FRAME STYLE

TXS1  **TiLite TX** (250 Pound Weight Limit. For Rear Seat Width **A** and Seat Depth **B** of 15", or greater, use K0009. For Rear Seat Width **A** and Seat Depth **B** of less than 15", use E1229.).....**\$3,295 K0009 E1229**

### FRAME FINISHES

#### Natural Titanium

- TXFF1  Satin .....**STD**
- TXSCBT1  Satin Finish Buffing Pads.....**\$15**
- TXFF2  Polished .....**\$650**
- TXFF3  Tattooed Titanium™ (Tattoos on front frame tubes. Frame finished in Satin. Click on the images below to view the Tattoos online.).....**\$250**
- TXFF4  Rock & Roll
- TXFF5  Retro



TXFF6  Mother Nature



TXFF7  Henna



#### High Gloss Paint

- TXFF8  Super Wet Black
- TXFF9  Sunburst Yellow
- TXFF10  TiLite Red
- TXFF11  Military Green
- TXFF12  Orange Crush
- TXFF13  Hot Pink ..... **STD**

#### Metallic Paint

- TXFF14  Ocean Blue Metallic
- TXFF15  Tangerine Metallic
- TXFF16  Salsa Red Metallic..... **STD**

#### Pearlescent Paint

- TXFF17  Midnight Blue Pearl
- TXFF18  White Pearl ..... **STD**



**THE ULTIMATE RIDE.®**  
 tilite.com  
 2701 West Court Street | Pasco, Washington 99301  
 509.586.6117 Tel | 800.545.2266 Toll-Free  
 509.586.2413 Fax | 866.586.2413 Toll-Free Fax

**THE TITANIUM EXPERTS.®**

**FRAME FINISHES**

**Matte Paint**

TXFF19  Black Lava

TXFF20  Deep Blue Ice

TXFF21  Scarlet Ice.....**STD**

**Candy Paint**

TXFF22  Ruby Red

TXFF23  Azure Blue

TXFF24  Root Beer Candy

TXFF25  Electric Plum

TXFF26  Atomic Green .....**STD**

**COLOR ANODIZE PACKAGE**

(Color Anodize Package includes Caster Fork. If no anodize color is selected, the default will be black.)

TXANO1  Black .....**STD**

TXANO3  Red Pepper TXANO4  Green Apple TXANO5  Sapphire .....**\$95**

**FRAME MEASUREMENTS**

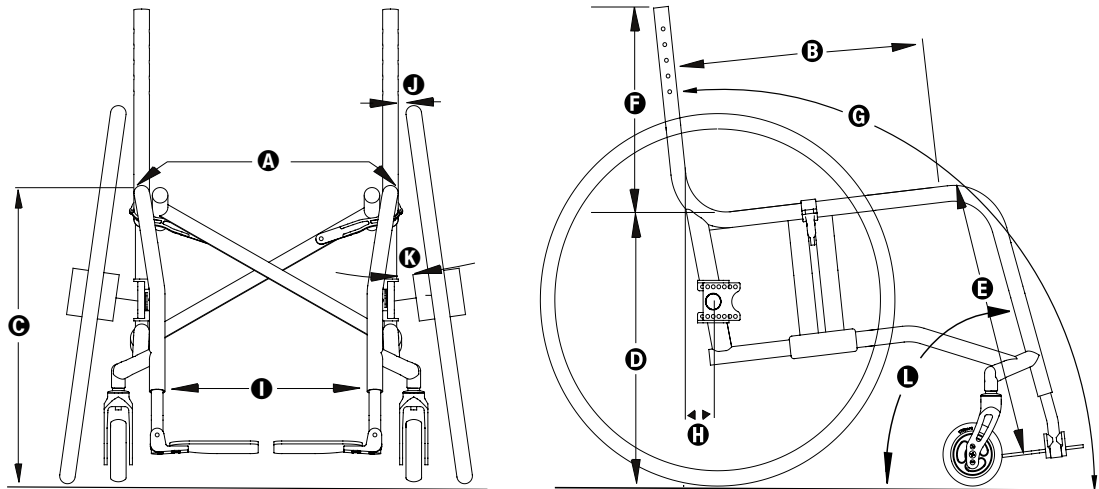

**SEAT WIDTH A** Measure from outside of seat tube to outside of the opposite seat tube.

TXSW1  12"  13"  14"  15"  16"  17"  18"  19".....**STD**

TXSW2  20" .....**\$300 E2201**

**SEAT DEPTH B** Measure from 1/2" in front of back post to the front edge of seat sling. (14" Seat Depth B not available with 25" and 26" Rear Wheels.)

TXSD1  14"  15"  16"  17"  18"  19".....**STD**

TXSD2  20" .....**\$300 E2203**

**FRONT SEAT HEIGHT C** Measure from the floor to top of seat tube at beginning of bend. Maximum difference of 3" is allowed between Front Seat Height C and Rear Seat Height D. (Seat Back Angle G limited to 90° - 100° with a difference of 3" between Front Seat Height C and Rear Seat Height D. Seat Back Angle G limited to 85° - 100° with a difference of 2.5" between Front Seat Height C and Rear Seat Height D.)

TXFSH1  15"  15.5"  16"  16.5"  17"  17.5"  18"  18.5"  19"  19.5".....**STD**

20"  20.5"  21".....**STD**

**REAR SEAT HEIGHT D** Measure from floor to top of seat tube at back post. Maximum difference of 3" is allowed between Front Seat Height C and Rear Seat Height D. (Seat Back Angle G limited to 90° - 100° with a difference of 3" between Front Seat Height C and Rear Seat Height D. Seat Back Angle G limited to 85° - 100° with a difference of 2.5" between Front Seat Height C and Rear Seat Height D.)

**REAR SEAT HEIGHT RANGES**

Rear Wheel Size	Rear Seat Height D		TXRSH1
	Fixed C.O.G H	Adj. C.O.G H	
22"	14" - 17.0"	14.0" - 16.5"	<input type="checkbox"/> 14" <input type="checkbox"/> 14.5" <input type="checkbox"/> 15" <input type="checkbox"/> 15.5"
24"	14" - 18.0"	14.0" - 17.5"	<input type="checkbox"/> 16" <input type="checkbox"/> 16.5" <input type="checkbox"/> 17" <input type="checkbox"/> 17.5"
25"	14" - 18.5"	14.5" - 18.0"	<input type="checkbox"/> 18" <input type="checkbox"/> 18.5" <input type="checkbox"/> 19"..... <b>STD</b>
26"	15" - 19.0"	15.5" - 18.5"	

**FRONT ANGLE I** Measure from frame front to floor. 80° Front Angle shown on Page 2.

70°  80°  85° (Not available with 6" Front Wheels.).....**STD**

**FRAME MEASUREMENTS**

**SEAT TO FOOTREST ③/FOOTRESTS** Measure from front edge of seat sling to top rear of footrest. **Measurement must be at least 2" shorter than Front Seat Height ②.**

**STANDARD FOOTRESTS**

- 13.5"  14"  14.5"  15"  15.5"  16"  16.5"  17"  17.5"  18"  18.5"  19"
- TXFTR5  Flip-up Footrest..... **STD**
- TXFTR6  1-Piece Flip-up Footrest (Pivot on  L or  R) (Not available with Heel Loops.)..... **\$125**
- TXFTR7  1-Piece, Over-Center Folding Footrest (Not available with Heel Loops.)..... **\$125**
- TXFTR8  1-Piece, Over-Center Angle Adjustable Footrest (Not available with Heel Loops. Available for 15" to 19" Seat to Footrest ③ only.)..... **\$295**
- TXFTR9  Depth Adjustable Flip-up Footrest..... **\$95**
- TXFTR10  Depth & Angle Adjustable Flip-up Footrest (Available for 15" to 19" Seat to Footrest ③ only.)..... **\$235**
- TXFTR11  Angle Adjustable Flip-up Footrest (Available for 15" to 19" Seat to Footrest ③ only.)..... **\$195**

**HIGH MOUNT FOOTRESTS** (Not Available with Tapered Footrest Width ①, Luggage Carriers or Impact Guards.)

- 7"  7.5"  8"  8.5"  9"  9.5"  10"  10.5"  11"  11.5"  12"  12.5"  13"
- TXFTR12  High Mount Flip-Up Footrest..... **\$165 K0037**
- TXFTR13  Depth Adjustable High Mount Flip-up Footrest..... **\$185**
- TXFTR15  Angle Adjustable High Mount Flip-up Footrest..... **\$285**
- TXFTR16  Depth & Angle Adjustable High Mount Flip-up Footrest..... **\$325**

- TXHLP1  **Heel Loops** (Not Available with 13" or narrower Seat Width ④ or 1-Piece Footrests.)..... **\$40 E0951**

**FOOTREST WIDTH ①** Find your Rear Seat Width ④ in the chart below and select one of the options to the right. Measure from inside of front frame tube to inside of opposite front frame tube. (2" Taper not Available with High Mount Footrests.)..... **STD**

**FOOTREST WIDTH ① (INSIDE MEASUREMENT) TXFW1**

Rear Seat Width ④ (Outside Measurement)	No Taper (2" Narrower than Seat Width)	2" Taper (4" Narrower than Seat Width)
12"	<input type="checkbox"/> 10"	<input type="checkbox"/> 8"
13"	<input type="checkbox"/> 11"	<input type="checkbox"/> 9"
14"	<input type="checkbox"/> 12"	<input type="checkbox"/> 10"
15"	<input type="checkbox"/> 13"	<input type="checkbox"/> 11"
16"	<input type="checkbox"/> 14"	<input type="checkbox"/> 12"
17"	<input type="checkbox"/> 15"	<input type="checkbox"/> 13"
18"	<input type="checkbox"/> 16"	<input type="checkbox"/> 14"
19"	<input type="checkbox"/> 17"	<input type="checkbox"/> 15"
20"	<input type="checkbox"/> 18"	<input type="checkbox"/> 16"

**FRAME MEASUREMENTS**

**SEAT BACK HEIGHT ③/SEAT BACK/PUSH HANDLES** Measure from top of back post to top of seat tube at rear of frame.

**SEAT BACK TYPE**

- TXSB13  Fixed Angle Adjustable-Height Seat Back.....**STD**
- TXSB18  Folding Adjustable-Angle and Height Seat Back.....**\$200**
- TXSB15  Non-Folding, Fixed-Height Titanium Seat Back.....**NCO**

**PUSH HANDLES**

- TXSB6  Integrated Push Handles (Not available with Non-Folding, Fixed Height Titanium Back.).....**NCO**
- TXSB7  Integrated Fold-Down Push Handles (Requires Tension Adjustable by Straps Back Upholstery. Not available with Non-Folding, Fixed Height Titanium Back.).....**\$100**
- TXSB9  Bolt-On Height Adjustable Push Handles (Requires Tension Adjustable by Straps Back Upholstery. Not available with Folding Adjustable-Angle and Height Seat Back, Non-Folding, Fixed Height Titanium Back. or Swing Away Tubular Armrests.).....**\$225**

**TXSB13 FIXED ANGLE ADJUSTABLE SEAT BACK HEIGHT ③**

Push Handles	Short	Medium	Tall	Set at: (Use 1/2" increments)
None	<input type="checkbox"/> 12" - 16"	<input type="checkbox"/> 14" - 18"	<input type="checkbox"/> 16" - 20"	Set at: _____
Integrated	<input type="checkbox"/> 13" - 16"	<input type="checkbox"/> 15" - 18"	<input type="checkbox"/> 17" - 20"	Set at: _____
Integrated Fold-Down		<input type="checkbox"/> 14" - 18.5"	<input type="checkbox"/> 16" - 20.5"	Set at: _____
Bolt-On Height Adj.	<input type="checkbox"/> 12" - 16"	<input type="checkbox"/> 14" - 18"	<input type="checkbox"/> 16" - 20"	Set at: _____

**TXSB18 FOLDING ADJUSTABLE- ANGLE AND HEIGHT SEAT BACK ③**

Push Handles	Short	Medium	Tall	Set at: (Use 1/2" increments)
None	<input type="checkbox"/> 13" - 15"	<input type="checkbox"/> 15.5" - 18.5"	<input type="checkbox"/> 18.5" - 21.5"	Set at: _____
Integrated	<input type="checkbox"/> 15" - 17"	<input type="checkbox"/> 16" - 19"	<input type="checkbox"/> 19" - 22"	Set at: _____
Integrated Fold-Down		<input type="checkbox"/> 16.5" - 18.5"	<input type="checkbox"/> 17.5" - 20.5"	Set at: _____

**TXSB15 NON-FOLDING, FIXED-HEIGHT TITANIUM SEAT BACK ③** (Titanium back will match Frame Finish. Required for fixed

Side Guards. Not available with Integrated Push Handles, Integrated Fold-Down Push Handles or Bolt-On Height Adjustable Push Handles.)

- 8"    8.5"    9"    9.5"    10"    10.5"    11"    11.5"    12"    12.5"
- 13"    13.5"    14"    14.5"    15"    15.5"    16"    16.5"    17"    17.5"
- 18"    18.5"    19"    19.5"    20"

**AVAILABLE ON ALL FIXED ANGLE BACKS**

- TXLB1  Folding Stabilizer Bar (Not Available with backrest height below 10.5" or Swing-Away Tubular Armrests.).....**\$340**



**SEAT BACK ANGLE ④** Measure angle from front of back post to floor. 90° will be perpendicular to the floor (Seat Back Angle ④ limited to 90° - 100° with a difference of 3" between Front Seat Height ⑤ and Rear Seat Height ⑥. Seat Back Angle ④ limited to 85° - 100° with a difference of 2.5" between Front Seat Height ⑤ and Rear Seat Height ⑥.) To approximate the angle from the back post to the seat, subtract 2 degrees from measurement ④ for every .5" of dump.

- TXSBA1  80°    81°    82°    83°    84°    85°    86°    87°    88°    89°    90°    91°  
 92°    93°    94°    95°    96°    97°    98°    99°    100°.....**STD**

**CENTER OF GRAVITY ⑤** Measure from the front of the back post at the seat tube to the center of the rear axle. With up to 1" difference between ④ and ⑥, a maximum of 3" forward is allowed. With 1.5" to 2.5" difference between ④ and ⑥, a maximum of 4" forward is allowed. With 3" difference between ④ and ⑥, a maximum of 5" forward is allowed. If no center of gravity is selected, chair will ship with the center of gravity in the rearward-most position

- TXCOG1  1"    1.25"    1.5"    1.75"    2"    2.25"    2.5"    2.75"    3"    3.25"    3.5"    3.75"  
 4"    4.25"    4.5"    4.75"    5"
- Adjustable Center Of Gravity.....**STD**
- Fixed Center Of Gravity (Not available with User Friendly Anti-Tips.).....**\$250**

**CHAIR OPTIONS**





**REAR WHEEL SPACING**  Measure from outside of seat back post to inside of rear tire. 3/4" Rear Wheel Spacing not available with 0° or 2° Camber .

- .75"  1"  1.25"  1.5"  1.75"  2".....**STD**









**CAMBER** 

- TXCBR8  0°  2°  4°.....**STD**
- TXCBR10  Additional Camber Plugs (Pair)  0°  2°  4°.....**\$100**

**FRONT WHEELS**

- TXFW1  3"x.75" Micro-Caster.....**STD**
- TXFW2  3"x.75" Light-Up Micro-Caster.....**\$65**
- TXFW14  4"x.75" Plastic Wheel w/Poly Tire.....**NCO**
- TXFW3  4"x.75" Light-Up Micro-Caster.....**\$65**
- TXFW19  4"x.75" Performance 5 Spoke Billet Aluminum Wheel w/Poly Tire  Silver Hub  Black Hub.....**\$125**
- TXFW20  4"x1" Performance 5 Spoke 2-Piece Billet Aluminum Wheel w/Soft Roll Tire  Silver Hub  Black Hub.....**\$165**
- TXFW15  4"x1.5" Plastic Wheel w/Poly Tire.....**\$80**
- TXFW6  5"x1" Plastic Wheel w/Poly Tire.....**NCO**
- TXFW21  5"x1" Performance 5 Spoke Billet Aluminum Wheel w/Poly Tire  Silver Hub  Black Hub.....**\$145**
- TXFW22  5"x1" Performance 5 Spoke 2-Piece Billet Aluminum Wheel w/Soft Roll Tire  Silver Hub  Black Hub.....**\$185**
- TXFW18  5"x1.5" Plastic Wheel w/Poly Tire.....**\$80**
- TXFW9  6"x1" Plastic Wheel w/Poly Tire (Not available with 85° Front Angle .).....**NCO**
- TXFW11  6"x1" Billet Aluminum Wheel w/Poly Tire  Silver Hub  Black Hub (Not available with 85° Front Angle .).....**\$165**
- TXFW10  6"x1.25" Plastic Wheel w/Pneumatic Tire (Not available with 85° Front Angle .).....**\$65**
- TXFW12  6"x1.25" Billet Aluminum Wheel w/Pneumatic Tire  Silver Hub  Black Hub (Not available with 85° Front Angle .) .....**\$165**
- TXFW13  6"x1.25" 2-Piece Billet Aluminum Wheel w/Soft Roll Tire (Not available with 85° Front Angle .).....**\$195**
- TXFRG1  Frog Legs® Suspension Forks (Available in Black anodize only).....**\$395 E1015**
- TXCPL1  Caster Pin Locks (Not available with Frog Legs®.).....**\$225 K0073**
- TXW0  Omit Front Wheels (Must choose Wheel Size above).....**\$20**

**REAR WHEELS**

- TXRW3 Spinergy WIRE Straight Pull w/Low Flange Hub (Not available with Titanium Quick Release Axles.).....**STD**
  - 22"(501)
  - 24"(540)
  - 25"(559) (Requires 15" minimum Seat Depth .)
  - 26"(590) (Requires 15" minimum Seat Depth .)
- TXRW5 TiLite Heat Treated Wheel w/High Flange Hub (Not available with Titanium Quick Release Axles.).....**\$250**
  - 24"(540)
  - 25"(559) (Requires 15" minimum Seat Depth .)
  - 26"(590) (Requires 15" minimum Seat Depth .)
- TXRW7 Spinergy SPOX  Black  Red  Yellow  Blue  White .....**\$695**
  - 22"(501) - Std. Hub
  - 24"(540) - Std. Hub
  - 25"(559) - Std. Hub (Requires 15" minimum Seat Depth .)
  - 26"(590) - Sport Hub (Requires 15" minimum Seat Depth . Not available with Titanium Quick Release or Quad Release Axles.)
- TXRW8 Spinergy LX  Black  Red  Yellow  Blue  White  Go Green  Bright Orange  Flamingo Pink (Please allow an additional 2-3 weeks delivery on Go Green, Bright Orange and Flamingo Pink.) .....**\$895**
  - 22"(501) - Std. Hub
  - 24"(540) - Std. Hub
  - 25"(559) - Std. Hub (Requires 15" minimum Seat Depth .)
  - 26"(590) - Sport Hub (Requires 15" minimum Seat Depth . Not available with Titanium Quick Release or Quad Release Axles.)
- TXRW11 Skyway Mags  22"  24" (Not available with Short Tabs or Titanium Quick Release Axles, Quad Release Axles or Spoke Guards.).....**\$50**
- TXRW0  Omit Rear Wheels (Must choose Wheel Size above and Tire Type below.).....**\$50**

**AXLES**

- TXAXL1  Stainless Quick Release.....**STD**
- TXAXL2  Titanium Quick Release (Not available with TiLite High Flange Hub, Spinergy WIRE, Skyway Mags, 26"(590) Spinergy SPOX or LX Rear Wheels.).....**\$195**
- TXAXL3  Quad Release (Not available with Skyway Mags or 26"(590) Spinergy SPOX or LX Rear Wheels.).....**\$95**

**CHAIR OPTIONS**

**PNEUMATIC REAR TIRES**

TXRTR1 <input type="checkbox"/> Treaded (Not available with 25"(559) Rear Wheels.).....	STD	
TXRTR2 <input type="checkbox"/> Airless Inserts .....	\$80	E2213
TXRTR3 <input type="checkbox"/> 25" Primo Treaded (Standard with 25"(559) Rear Wheels.).....	STD	
TXRTR4 <input type="checkbox"/> Primo .....	NCO	
TXRTR5 <input type="checkbox"/> 24", 25" and 26" Kenda® High Pressure (110psi) <input type="checkbox"/> Grey <input type="checkbox"/> Red <input type="checkbox"/> Blue.....	\$85	
TXRTR6 <input type="checkbox"/> 24" Grey Knobby (Requires TiLite Wheel with High Flange Hub.).....	\$95	
TXRTR7 <input type="checkbox"/> 26" Black Knobby (Requires TiLite Wheel with High Flange Hub or Spinergy SPOX or Spinergy LX Rear Wheels. ).....	\$95	
TXRTR8 <input type="checkbox"/> 24", 25" and 26" Schwalbe® Marathon Plus Evolution.....	\$110	
TXRTR9 <input type="checkbox"/> 24" and 25" Schwalbe® SpeedRun.....	\$125	

**SOLID REAR TIRES**

TXRTR11 <input type="checkbox"/> 22"(501) Pyramid.....	\$75
TXRTR13 <input type="checkbox"/> 24"(540) and 25"(559) Herringbone Tread.....	\$90
TXRTR15 <input type="checkbox"/> 24"(540) and 25"(559) Treaded.....	\$90

**HANDRIMS**



**Handrim Type**

TXRIM1 <input type="checkbox"/> Aluminum – Silver Anodized.....	STD
TXRIM2 <input type="checkbox"/> Titanium (Not available with Skyway Mags, 22" Rear Wheels, or 24" Knobby tires.)	
<input type="checkbox"/> Satin Finish.....	\$400
<input type="checkbox"/> Polished Finish.....	\$550
TXRIM3 <input type="checkbox"/> The Natural-Fit® (Original, Larger Profile) (Not available with Skyway Mags.)	
<input type="checkbox"/> Standard Grip (Not available with short tabs.).....	\$295
<input type="checkbox"/> Super Grip (Not available with short tabs.).....	\$340
<input type="checkbox"/> Without Thumb Grip.....	\$270
TXRIM4 <input type="checkbox"/> The Natural-Fit® LT (Reduced Weight, Smaller Profile) (Not available with Skyway Mags.)	
<input type="checkbox"/> Standard Grip (Not available with short tabs.).....	\$325
<input type="checkbox"/> Super Grip (Not available with short tabs.).....	\$370
<input type="checkbox"/> Without Thumb Grip.....	\$300
TXRIM9 <input type="checkbox"/> Spinergy FlexRim (Available only on 24" and 25" Spinergy LX Rear Wheels. Please allow an additional 2-3 weeks delivery.) .....	\$495
TXRIM5 <input type="checkbox"/> Plastic Coated – Black.....	\$95
TXRIM6 <input type="checkbox"/> Projections - 8 Vertical (Not available with 20", 22" or 26" Rear Wheels or Skyway Mags.).....	\$240
TXRIM0 <input type="checkbox"/> Omit Handrims.....	\$15

**Tab Length**

TXRIM7 <input type="checkbox"/> Long Tabs.....	STD
TXRIM8 <input type="checkbox"/> Short Tabs (Not available with Skyway Mags or The Natural-Fit® Handrims with Thumb Grip.).....	\$15

**WHEEL LOCKS**

TXWLK1 <input type="checkbox"/> Standard Push to Lock (Available with .75" to 1.5" Rear Wheel Spacing  only. Not available with 13" or shorter Seat Depth  .) .....	NCO
TXWLK6 <input type="checkbox"/> Extension Handles for Standard Push to Lock.....	\$75 E0961
TXWLK2 <input type="checkbox"/> Composite Scissor Lock.....	\$110
TXWLK3 <input type="checkbox"/> Uni-Lock Set At: <input type="checkbox"/> Push <input type="checkbox"/> Pull.....	\$135
TXWLK4 <input type="checkbox"/> Extension Handles for Uni-Lock.....	\$50 E0961

**UPHOLSTERY COLORS**

TXUPC1 <input type="checkbox"/> Black.....	STD
TXUPC2 <input type="checkbox"/> Ti Red <input type="checkbox"/> Royal Blue <input type="checkbox"/> Navy Blue <input type="checkbox"/> Hunter Green <input type="checkbox"/> Purple <input type="checkbox"/> Digital Camo.....	\$50

**BACK UPHOLSTERY**

TXBUP2 <input type="checkbox"/> Micro Adjustable (Not available with Fold-Down Push Handles.).....	STD
TXBUP3 <input type="checkbox"/> Tension Adjustable by Straps (Required with Fold-Down Push Handles.).....	\$150
TXBUP0 <input type="checkbox"/> Omit Back Upholstery.....	NCO

**CHAIR OPTIONS**

**SEAT UPHOLSTERY**

- TXSUP4  Tension Adjustable (Black only).....**STD**
- TXSUP0  Omit Seat Upholstery.....**NCO**

**SEAT CUSHIONS**

- TXCSH1  Foam Cushion  2"  3"  4".....**\$95**
- TXCSH2  StimuLITE® Sport (2" Black 13"x15" to 20"x 20". Please allow an additional 2-3 weeks delivery.).....**\$495 E2603**
- TXCSH3  Corbee® (2" Black 12"x 12" to 16"x 16". Please allow an additional 2-3 weeks delivery.).....**\$495 E2603**
- TXCSH4  ROHO® Low Profile® Quadtro® Select (Please allow an additional 2-3 weeks for delivery.).....**\$525 K0736**
- TXCSH5  ROHO® Custom (Please allow an additional 2-3 weeks for delivery.).....**\$625 K0734**
- TXCSH6  VARILITE® Evolution™ (Black only. See chart below.).....**\$495 K0734**
- TXCSH7  VARILITE® Zoid™ (Black only. See chart below.).....**\$495 K0734**

**VARILITE® CUSHION AVAILABILITY CHART**

Seat Width Ⓐ	Seat Depth Ⓑ	
	VARILITE® Evolution™	VARILITE® Zoid™
12"	14"	8", 12", 14"
13"	NONE	NONE
14"	14", 16", 18", 20"	14", 16", 18"
15"	15", 17"	15", 17"
16"	14", 16", 18", 20"	16", 18", 20"
17"	17"	17"
18"	16", 18", 20"	16", 18", 20"
19"	NONE	NONE
20"	16", 18", 20"	16", 18", 20"

**SIDE GUARDS**

- TXSDG1  Cloth.....**\$45**

**Aluminum**

- TXSDG2  Rigid Removable  Small  Std.....**\$175**
- TXSDG3  Quad Removable w/Hole  Small  Std.....**\$185**
- TXSDG5  Fixed (Requires Fixed Height Titanium Back.).....**\$300**

**Carbon Fiber**

- TXSDG7  Rigid Removable  Small  Std.....**\$270**
- TXSDG8  Quad Removable w/Hole  Small  Std.....**\$280**
- TXSDG10  Fixed (Requires Fixed Height Titanium Back.).....**\$375**

**Available on Aluminum and Carbon Fiber Non-Fendered Side Guards**

- TXSDG13  Side Guards Custom Cut to Profile of Rear Wheels (Not available with Cloth.).....**\$275**

**ARMRESTS**

- TXARM1  Swing Away Tubular (Not Available with Height Adjustable Push Handles or Folding Stabilizer Bar.).....**\$195 E0973**

- TXARM2  Removable Height Adjustable Desk Arm with Rigid Side Guard (Requires 14" minimum Seat Depth Ⓑ.)

- Standard Length Pad (10")  Full Length Pad (14")
- 9" to 12"  12" to 15".....**\$350 E0973**

- TXARM3  Removable Height Adjustable Desk Arm with Rigid Side Guard and Transfer Loop (Requires 15" minimum Seat

Depth Ⓑ.)

- Standard Length Pad (10")  Full Length Pad (14")
- 9" to 12"  12" to 15".....**\$395 E0973**

**Available on all Armrests**

- Covered in Black Ultrasuede.....**\$75**

**SEAT BELTS**

- TXBLT1  Velcro Adjustable, Black Nylon Webbing.....**\$45 E0978**

- TXBLT2  Bodypoint® Auto-Style Release Buckle.....**\$85 E0978**

**CALF STRAP**

- TXCLF1  Buckle Adjustable, Black Nylon Webbing.....**\$25 K0038**

- TXCLF2  Velcro Adjustable.....**\$35 K0038**

- Small (Recommended for 12"- 15" Seat Widths)
- Medium (Recommended for 14"- 18" Seat Widths)
- Large (Recommended for 17"- 19" Seat Widths)
- Xtra Large (Recommended for 18"- 20" Seat Widths)

- TXCLF3  Bodypoint® Padded Velcro Adjustable.....**\$75 K0038**

- Medium (Recommended for 12"- 15" Seat Widths)
- Large (Recommended for 16"- 20" Seat Widths)

**CHAIR OPTIONS**

**BACK PACK**

- TXBCK1  Small - Black Nylon .....\$50
- TXBCK2  Large - Black Nylon.....\$65

**SEAT POUCH**

- TXPCH1  Small - Black Nylon.....\$40
- TXPCH2  Large - Black Nylon.....\$45

**SPOKE GUARDS**

- TXGRD1  Clear with TiMotion Logo (Not available with Skyway Mags.) .....\$110 K0065

**ANTI-TIPS**

- TXTIP1  Rear Aluminum - Black.....\$135 E0971
- TXTIP2  User Friendly Rear Flip-up (Not available with a Fixed Center of Gravity.).....\$245 E0971

**ACCESSORIES**

- TXLUG1  Luggage Carriers (Not available with High Mount Footrests.).....\$125
- TXMPCT1  Neoprene Impact Guards (Not available with High Mount Footrests. Impact Guards will match upholstery color.).....\$75
- TXCH1  Crutch Holder.....\$65 E2207
- TXTS1 TiLite T-Shirt  Small  Medium  Large  X-Large  XX-Large.....\$20
- TXHS1  TiLite 9 Piece SAE Round Handle Folding Hex Key Set.....\$20
- TXAFP1 4" Logo Patch  Army  Navy  Air Force  Marines .....\$50
- TXAFP2 Name Tape Patch  Army  Navy  Air Force  Marines .....\$50
- TXAFP3  Combat Wounded Purple Heart Patch.....\$50

**DESIGNS UNLIMITED**



TiLite's TX offers millions of different frame combinations! But sometimes even that's not enough. If you would like to customize your TiLite, check out the Designs Unlimited Studio at [www.tilite.com](http://www.tilite.com). There you will find drawings and pricing for hundreds of creative solutions to customers' customization requests. We call these "D.U.'s." If you don't find the D.U. you're looking for, contact the TiLite Customer Service Team at 800.545.2266 or [customerservice@tilite.com](mailto:customerservice@tilite.com) and we'll design a D.U. just for you. Designs Unlimited customization may add an additional 2 to 3 weeks to the ship time of your chair.

**TILITE ORDERING PROCESS**

Upon submitting this Order Form, you will receive either a TiLite QUOTE or a TiLite ORDER CONFIRMATION. Please CAREFULLY EXAMINE the QUOTE or ORDER CONFIRMATION for NOTES written by TiLite's Customer Service Team. These notes must be addressed by you before TiLite can process your order. The FOOTNOTES contained in this Order Form are CRITICAL. Please REVIEW all FOOTNOTES while completing the Order Form. If you have requested a DRAWING of this chair, a copy of the drawing SIGNED by YOU must be received by TiLite before TiLite can process the order.

**GENERAL**

TiLite manufactures a wide variety of wheelchairs to meet the varied needs of wheelchair users. The final selection of a particular model, its options and accessories, and its measurements rests solely with the wheelchair user and advising healthcare professional. TiLite wheelchairs must be fitted by a qualified healthcare professional. HCPCS Codes are for reference purposes only. Actual coding and coverage varies by payer. Proper HCPCS coding is not a guarantee of payment. Please verify the appropriate payer's coverage policy.

**Get the latest order forms at [tilite.com](http://tilite.com)** Prices, standard features, options and accessories are subject to change without notice. All rights reserved. Trademarks are identified by symbols™ and ©. TiLite, the TiLite logo, Ti, the Ti logo, The Titanium Experts, TiShaft and The Ultimate Ride are registered trademarks of TiSport, LLC. Adobe®, Acrobat®, Acrobat Professional® and Reader® are registered trademarks of Adobe Systems Inc. Alcantara® is a registered trademark of Alcantara S.p.A. Bodypoint® is a registered trademark of Bodypoint Inc. Frog Legs® is a registered trademark of Frog Legs, Inc. Kenda® is a registered trademark of Kenda Rubber Industrial Co Ltd. Ride Designs® and Corbac® are registered trademarks of Aspen Seating, LLC. ROHO®, Low Profile® and Quadtro Select® are registered trademarks of ROHO Inc. Schwalbe® is a registered trademark of Ralf Bohle GmbH. Supracor®, Stimulite® and Corbee® are registered trademarks of Supracor, Inc. The Natural-Fit® is a registered trademark of Three Rivers Holdings, LLC. Ultrasuede® is a registered trademark of Toray Ultrasuede (America), Inc. Varilite® is a registered trademark of Cascade Designs, Inc..

**NOTES**

---



---



---

If you are using Adobe Acrobat, this order form may be converted into a quote request or into an order by clicking one of the buttons below (this feature is available exclusively to TiLite dealers and distributors). A TiLite Quote or a TiLite Order Confirmation will be sent to you within 24 hours.

**QUOTE THIS CHAIR**

**ORDER THIS CHAIR**